

ConSig

## Control and monitoring devices

ConSig 8040 series

## Contents

1	General Information .....	3
1.1	Manufacturer .....	3
1.2	Information regarding the Operating Instructions .....	3
1.3	Further Documents .....	3
1.4	Conformity with Standards and Regulations .....	3
2	Explanation of the Symbols .....	3
2.1	Symbols in these Operating Instructions .....	3
2.2	Warning Notes .....	4
2.3	Symbols on the Device .....	4
3	Safety Notes .....	5
3.1	Operating Instructions Storage .....	5
3.2	Personnel Qualification .....	5
3.3	Safe Use .....	5
3.4	Modifications and Alterations .....	6
4	Function and Device Design .....	7
4.1	Function .....	7
5	Technical Data .....	7
6	Transport and Storage .....	12
7	Mounting and Installation .....	12
7.1	Dimensions / Fastening Dimensions .....	13
7.2	Mounting / Dismounting, Operating Position .....	14
7.3	Installation .....	14
8	Commissioning .....	16
9	Maintenance and Repair .....	17
9.1	Maintenance .....	17
9.2	Maintenance .....	17
9.3	Repair .....	17
9.4	Returning the Device .....	18
10	Cleaning .....	18
11	Disposal .....	18
12	Accessories and Spare Parts .....	18

## 1 General Information

### 1.1 Manufacturer

R. STAHL Schaltgeräte GmbH  
Am Bahnhof 30  
74638 Waldenburg  
Germany

Phone: +49 7942 943-0  
Fax: +49 7942 943-4333  
Internet: [www.stahl-ex.com](http://www.stahl-ex.com)  
E-Mail: [info@stahl.de](mailto:info@stahl.de)

### 1.2 Information regarding the Operating Instructions

ID-No.: 130937 / 8040606300  
Publication Code: 2016-05-24-BA00-III-en-04

The original instructions are the English edition.  
They are legally binding in all legal affairs.

### 1.3 Further Documents



- Data sheet
- For documents in further languages, see [www.stahl-ex.com](http://www.stahl-ex.com).

### 1.4 Conformity with Standards and Regulations

See certificates and EU Declaration of Conformity: [www.stahl-ex.com](http://www.stahl-ex.com).  
The device has IECEx approval. See IECEx homepage: <http://iecex.iec.ch/>

## 2 Explanation of the Symbols



### 2.1 Symbols in these Operating Instructions

Symbol	Meaning
	Tips and recommendations on the use of the device
	Danger due to explosive atmosphere
	Danger due to live components



## 2.2 Warning Notes

Warnings must be observed under all circumstances, in order to minimize the risk due to construction and operation. The warning notes have the following structure:

- Signalling word: DANGER, WARNING, CAUTION, NOTICE
- Type and source of danger/damage
- Consequences of danger
- Taking countermeasures to avoid the danger or damage

	<b>DANGER</b>
	Danger to persons Non-compliance with the instruction results in severe or fatal injuries to persons.
	<b>WARNING</b>
	Danger to persons Non-compliance with the instruction can result in severe or fatal injuries to persons.
	<b>CAUTION</b>
	Danger to persons Non-compliance with the instruction can result in light injuries to persons.
<b>NOTICE</b>	
Avoiding material damage Non-compliance with the instruction can result in material damage to the device and / or its environment.	

## 2.3 Symbols on the Device

Symbol	Meaning
 <small>05594E00</small>	CE marking according to the current applicable directive.
 <small>02198E00</small>	Electric circuit certified for hazardous areas according to the marking.
 <small>11048E00</small>	Safety instructions that must always be followed: The respective data must be noted and/or the safety-related instructions contained in the operating instructions must be followed for devices with this symbol!

## 3 Safety Notes

### 3.1 Operating Instructions Storage

- Read the operating instructions carefully.
- Store the operating instructions at the mounting location of the device.
- Observe applicable documents and operating instructions of the devices to be connected.

### 3.2 Personnel Qualification

Qualified specialist personnel are required to perform the tasks described in these operating instructions. This primarily applies to work in the following areas:

- Project engineering
- Mounting/dismounting the device
- (Electrical) installation
- Commissioning
- Maintenance, repairs, cleaning

Specialists who perform these tasks must have a level of knowledge that complies with the following regulations:

- All national standards and regulations

Additional knowledge is required for tasks in areas subject to explosion hazards!

R. Stahl recommends having a level of knowledge equal to that described in the following standards:

- DIN EN 60079-14 (Electrical installations design, selection and erection)
- DIN EN 60079-17 (Electrical installations inspection and maintenance)
- DIN EN 60079-19 (Equipment repair, overhaul and reclamation)

### 3.3 Safe Use

#### Before mounting

- Read and observe the safety notes in these operating instructions!
- Ensure that the contents of these operating instructions are fully understood by the personnel in charge.
- Use the device in accordance with its intended and approved purpose only.
- Consult with R. STAHL Schaltgeräte GmbH if using the device under operating conditions which are not covered by the technical data.



**For assembly and installation**

- Observe national assembly and installation regulations (e.g. IEC/EN 60079-14).
- Observe national safety and accident prevention regulations.
- During installation and operation, observe the information (characteristic values and rated operating conditions) on the type plates and data plates and information signs located on the device.
- Before installation, make sure that the device is not damaged
- Only use installation components (e.g. cable entries) that have an "EC Type Examination Certificate" or an "IECEX Certificate of Conformity".
- Observe the installation conditions of potential installation components (See the "Technical data" section).
- Ensure that cable entries from manufacturers other than R. STAHL have a correct and sufficient degree of protection.
- Do not subject cable entries and stopping plugs to any tensile stress and tighten them with the right torque (for information on torque, see the operating instructions for the cable gland).

**Maintenance, repair, commissioning**

- Before commissioning, make sure that the device is not damaged.
- Work on the device, such as installation, maintenance, overhaul, repair, may only be carried out by appropriately authorised and trained personnel (see Section 3.2).
- Perform only maintenance work or repairs described in these operating instructions.

**3.4 Modifications and Alterations**

	<b>DANGER</b>
	<p>Explosion hazard due to modifications and alterations to the device!                  Non-compliance results in severe or fatal injuries.</p> <ul style="list-style-type: none"> <li>• Do not modify or alter the device.</li> </ul>
	<p>No liability or warranty for damage resulting from modifications and alterations.</p>

## 4 Function and Device Design

	DANGER
	<p>Explosion hazard due to improper use! Non-compliance results in severe or fatal injuries.</p> <ul style="list-style-type: none"> <li>• Use the device only in accordance with the operating conditions described in these operating instructions.</li> <li>• Use the device only for the intended purpose specified in these operating instructions.</li> </ul>

### 4.1 Function

#### Application range

The control devices of Series 8040 are explosion-protected equipment for stationary mounting, certified for use in hazardous areas of Zones 1, 2 and 21, 22. They are used for control and switching functions in areas subject to explosion hazards.

## 5 Technical Data

### Explosion Protection

#### Global (IECEX)

Gas and dust

IECEX PTB 06.0025

Ex db eb ia ib [ia Ga] mb q IIA, IIB, IIC, T6, T5, T4 Gb

Ex tb IIIC T80°C, T95°C, T130°C Db

#### Europe (ATEX)

Gas and dust

PTB 01 ATEX 1105

⊕ II 2 G Ex db eb ia ib [ia Ga] mb q IIA, IIB, IIC, T6, T5, T4 Gb

⊕ II 2 D Ex tb IIIC T80°C, T95°C, T130°C Db

#### Certifications and certificates

Certificates

IECEX, ATEX, India (PESO), Canada (CSA), Kazakhstan (TR), North America (cULus), Russia (TR), Taiwan (ITRI), Belarus (TR)

Ship approval

DNV GL

Technical Data	
Version	8040
Ambient conditions	
Operating temperature range	see rating plate
Rated operational voltage	max. 690 V AC
Rated operational current	depends on components used
Cable entry	Standard: 1 x M25 x 1.5; cable glands 8161; side below (D); directly mounted into enclosure wall  Special version: In side C (top) and/or D (bottom); 1 x M20 x 1.5; 1 x M25 x 1.5 Metal cable glands are possible; Mounting of metal cable glands in metal flange or via metal adapter plate
Connection cross-section	max. 2.5 mm <sup>2</sup>
Tightening torque	max. 1.4 Nm cover lock
Structure:	
Standard	without flange
Option	with flange made of polyester resin or brass, can be fitted on sides C and D
Degree of protection	IP66 in accordance with IEC/EN 60529 (others on request)
Material	
Enclosure material	Polyester resin, glass-fibre-reinforced
Seal	Silicone, foamed
Cover fixing	with captive M4 stainless steel socket head cap screws



Technical data of potential built-in components from R. STAHL Schaltgeräte GmbH:

Technical Data

Version	Type 8010 Indicating lamp
Certificates	
Global (IECEX)	IECEX PTB 06.0016U
Europe (ATEX)	PTB 01 ATEX 1160 U
Ambient temperature	8010/2    -60 to +65 °C at U = 24 to 120 V -60 to +60 °C at U > 120 V 8010/3    -60 to +65 °C at U < 24 V -60 to +60 °C at U = 24 to 30 V
Rated operational voltage	Ex e: 12 ... 240 V, AC / DC (± 10%) Ex i: 10.8 ... 30 V DC
Rated operational current I <sub>e</sub>	Ex e: max. 15 mA
Rated operational power	max. 1 W
Frequency range	0 to 60 Hz

Technical Data

Version	Type 8405 Ammeter
Certificates	
Global (IECEX)	IECEX PTB 06.0017 U
Europe (ATEX)	PTB 01 ATEX 2158 U
Ambient temperature at temperature class	T6: -50 to +40 °C (eb) T6: -20 to +40 °C (mb)
Rated operational voltage	max. 690 V
Accuracy	Class 2.5

**Technical Data**

Version	Type 8208 Control unit				
Certificates					
Global (IECEX)	IECEX PTB 06.0032U				
Europe (ATEX)	PTB 01 ATEX 1066 U				
Rated operational voltage	max. 550 V when switching instrumentation and control circuits: 8 ... 30 V DC				
Ambient temperature at temperature class	-60 to +60 °C, see "Max. power" table 8208/24-08 (potentiometer): -55 to +60 °C, see "Max. power" table				
Max. power	<b>Maximum internal heat distribution</b> (Connection to 1.5 mm <sup>2</sup> conductor cross-section and maximum 5 A)				
	Type	Ambient temperature max. 40 °C	Ambient temperature max. 60 °C		
		T <sub>surface</sub> = max. 80 °C	T <sub>surface</sub> = max. 95 °C	T <sub>surface</sub> = max. 80 °C	T <sub>surface</sub> = max. 95 °C
	8208/1	3.0 W	4.75 W	1.5 W	2.0 W
	8208/2	2.0 W		1.0 W	

**Technical Data**

Version	Type 8082 Contact element	
Certificates		
Global (IECEX)	IECEX PTB 06.0011U	
Europe (ATEX)	PTB 00 ATEX 1031 U	
Rated operational voltage	max. 500 V	
Ambient conditions		
Ambient temperature at temperature class	-60 to +70 °C	
Rated operating characteristics referring to utilization category	<b>AC-12 utilisation category</b> Rated operational voltage      550 V Rated operational current      max. 10 A Switching capacity              max. 3000 W	
	<b>DC-13 utilisation category</b> Rated operational voltage      110 V Rated operational current      max. 6 A Switching capacity              max. 110 W	

**Technical Data**

Version	Type 8008 Control switch		
Certificates			
Global (IECEX)	IECEX PTB 06.0010U		
Europe (ATEX)	PTB 00 ATEX 1111 U		
Rated operational voltage	max. 690 V AC / 230 V DC		
Utilization category	AC-1	16 A	690 V
	AC-3	8 A	500 V
	AC-3	4 A	690 V
	AC-15	16 A	415 V
	DC-1	6 A	220 V (3-pole)
Ambient temperature at temperature class	T6 at 16 A: -60 to +60 °C		

**Technical Data**

Version	Type 8453 control unit		
Certificates			
Global (IECEX)	IECEX PTB 06.0031 U		
Europe (ATEX)	PTB 01 ATEX 1067 U		
Rated insulation voltage	max. 550 V		
Ambient temperature at temperature class	T6: -60 to +50 °C T4: -60 to +75 °C		
Power dissipation	Vertical installation		
	Maximum surface temperature	maximum permissible integrated power dissipation depending on the ambient temperature	
		-60 °C	-60 °C
		≤ Ta ≤	≤ Ta ≤
		+50 °C	+60 °C
	80 °C (T6)	1.1 W <sup>1)</sup>	0.8 W <sup>2)</sup>
	95 °C (T5)	1.1 W <sup>1)</sup>	1.1 W <sup>1)</sup>
	100 °C <sup>3)</sup> (T4)	1.1 W <sup>1)</sup>	1.1 W <sup>1)</sup>
			0.8 W <sup>2)</sup>
		<sup>1)</sup> 27 K - Max. temperature rise <sup>2)</sup> 20 K - Max. temperature rise <sup>3)</sup> 100 °C - Max. permissible operating temperature (material limit)	

## Technical Data

Power dissipation	Horizontal installation			
	Maximum surface temperature	maximum permissible integrated power dissipation depending on the ambient temperature		
		-60 °C ≤ Ta ≤ +50 °C	-60 °C ≤ Ta ≤ +60 °C	-60 °C ≤ Ta ≤ +75 °C
	80 °C (T6)	1.1 W <sup>1)</sup>	-	-
	95 °C (T5)	1.1 W <sup>1)</sup>	1.1 W <sup>1)</sup>	-
	100 °C <sup>3)</sup> (T4)	1.1 W <sup>1)</sup>	1.1 W <sup>1)</sup>	0.8 W <sup>2)</sup>
	<sup>1)</sup> 30 K - Max. temperature rise			
	<sup>2)</sup> 23 K - Max. temperature rise			
	<sup>3)</sup> 100 °C - Max. permissible operating temperature (material limit)			

For further technical data, see [www.stahl-ex.com](http://www.stahl-ex.com).

## 6 Transport and Storage

- Transport and store the device only in the original packaging.
- Store the device in a dry place (no condensation) and vibration-free.
- Do not drop the device.

## 7 Mounting and Installation

The device is approved for use in gas explosion hazardous areas of Zones 1 and 2 and dust explosion hazardous area of Zones 21 and 22 and in safe areas.

## 7.1 Dimensions / Fastening Dimensions

Dimensional drawings (All dimensions in mm [inches]) – Subject to modifications

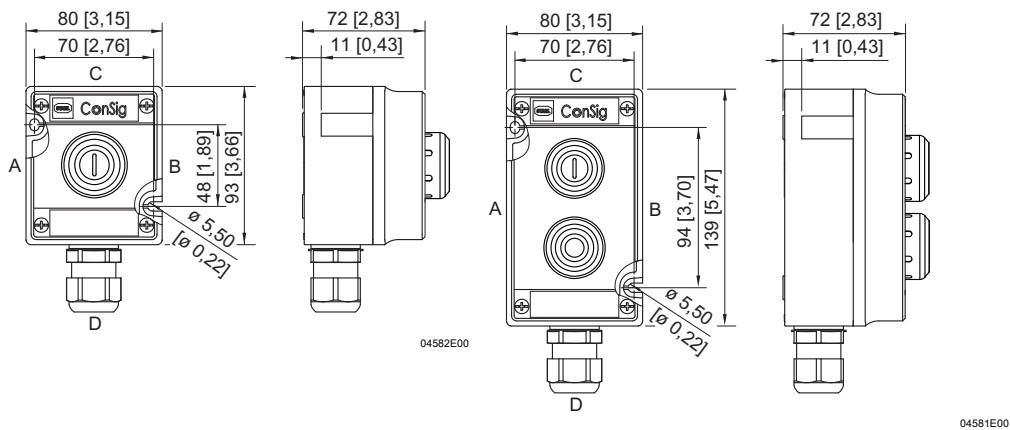

**ConSig 8040/11**

**ConSig 8040/12**

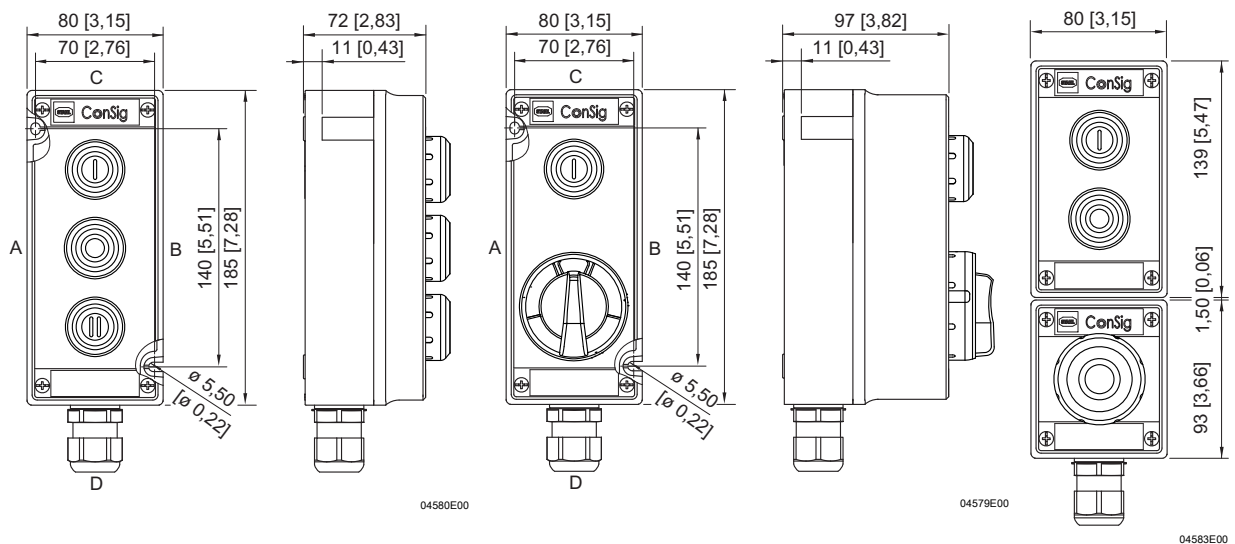

**ConSig 8040/13**

**ConSig 8040/23**

**ConSig 8040/11  
and  
ConSig 8040/12  
device  
combination**

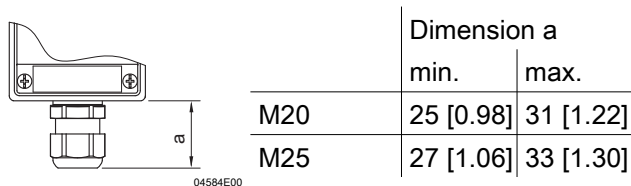

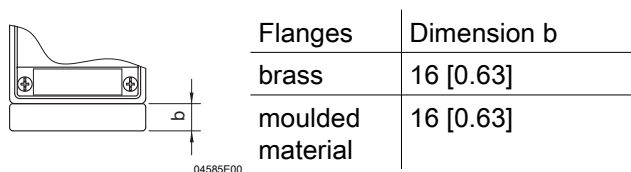

Additional dimensions for 8161 cable glands



Additional dimension for flanges

## 7.2 Mounting / Dismounting, Operating Position

	DANGER
	<p>Explosion hazard due to defective seal after dismantling the flange!                  Non-compliance results in severe or fatal injuries.</p> <ul style="list-style-type: none"> <li>• Do not dismantle the flange once it has been mounted.</li> </ul>
	<p>After the customer dismantles the flange, it only has an IP65 degree of protection.</p>

This device is suitable for outdoor and indoor use.

- Provide a protective roof or wall if enclosure and explosion protected electrical equipment is used outdoors.

## 7.3 Installation

	<p>Operation under difficult conditions, such as, in particular, on ships, requires additional measures to be taken for correct installation, depending on the place of use. Further information and instructions on this can be obtained from your regional sales contact on request.</p>
---	--

### 7.3.1 Mount Cable Entries

The following cable entries can be used to insert cables and conductors:

- Plastic or metal cable entries for permanently installed electric lines or
- Plastic or metal cable entries with strain relief for electric lines, which are not permanently installed.

To seal unused entry holes,

- stopping plugs made of plastic (Series 8290) or metal (Series 8294) can be used.

	DANGER
	<p>Explosion hazard due to unsuitable cable entries at a low ambient temperature!                  Non-compliance results in severe or fatal injuries.</p> <ul style="list-style-type: none"> <li>• At low ambient temperatures (<math>&lt; -20\text{ °C}</math>), use cable entries (material, insulation) specially designed for these temperatures or provide cable entries and actuators with special protection (e.g. using a mechanical safety device).</li> </ul>

	DANGER
<p>Explosion hazard due to open drilled holes and unused cable entries! Non-compliance results in severe or fatal injuries.</p> <ul style="list-style-type: none"> <li>• Tightly seal open drilled holes using certified stopping plugs (e.g. Type 8290) and unused cable entries using certified plugs (e.g. Type 8161).</li> </ul>	

### 7.3.2 Conductor Connection

- Select suitable conductors that do not exceed the permitted heating temperature within the enclosure.
- Ensure that conductors have the specified cross sections.
- Guide the conductor insulation so that it reaches the terminals.
- Do not damage the conductor when stripping the insulation (e.g. by denting it).
- Attach the core end sleeves properly.
- If the system is equipped with all possible clamps and live conductors, and the maximum current load has been reached, ensure that the length of a conductor from the screw connection to the terminal point does not exceed the diagonal planes of the enclosure.

#### Connecting conductors to built-in elements with screw terminals:

Where built-in elements have screw terminals, 1 or 2 cables may be connected to a single connection terminal. In case of solid conductors, both conductors must have the same cross section and must be made of the same material.

The conductors can be connected without previous measures.

#### Connecting conductors to built-in elements with screwless terminals (contact elements shown as example):

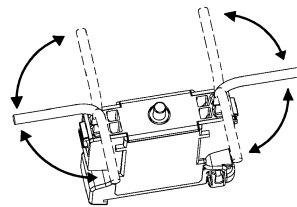
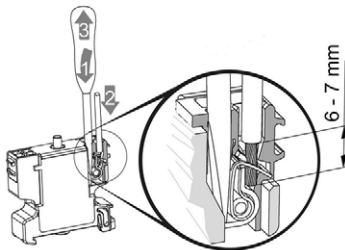

05886E00

05565E00

**Intrinsically safe circuits**

Comply with the following conditions when setting up intrinsically safe electric circuits:

- In intrinsically safe circuits, only insulated conductors with a test voltage of at least 500 V AC and a minimum quality of H05 may be used.
- The diameter of individual conductors must not be less than 0.1 mm; this also applies to the individual wires of finely stranded conductors.
- With regard to the insulation and separation of terminals and conductors, note that the insulation test voltage is determined from the sum of the rated operational voltages of intrinsically safe and non-intrinsically safe circuits.
- In case of "intrinsically safe to earth", there is a minimum rated insulation voltage value of 500 V (otherwise, double the value of the rated operational voltage of intrinsically safe circuits).
- In the case of "intrinsically safe to non-intrinsically safe", there is a minimum rated insulation voltage value of 1500 V (otherwise double the rated operational voltage plus 1000 V).
- The electric lines for Ex "i" electric circuits must be run at least 8 mm away from the conductors of other intrinsically safe circuits. The only exception is the wiring method by which the cores of the intrinsically safe or the non-intrinsically safe circuit are surrounded by an earthed shield.

**The pre-conditions for the distance between parts to be connected for intrinsically safe and non-intrinsically safe circuits are:**

- A distance of 50 mm around an insulating ( $\geq 1$  mm thick) or earthed metal ( $\geq 0.45$  mm thick) isolating plate or
- An isolating plate which is separated from enclosure walls by a distance of  $\leq 1.5$  mm.

## 8 Commissioning

	DANGER
	<p>Explosion hazard due to incorrect installation! Non-compliance results in severe or fatal injuries.</p> <ul style="list-style-type: none"> <li>• Check the device for proper installation before commissioning.</li> <li>• Comply with national regulations.</li> </ul>

Before commissioning, ensure the following:

- Check the mounting and installation.
- Inspect enclosure for damage.
- If necessary, remove foreign bodies.
- If necessary, clean the connection chamber.
- Check if the conductors have been inserted correctly.
- Check if all screws and nuts have been tightened firmly.
- Check whether all the cable entries and stopping plugs have been tightened firmly.
- Check if all conductors have been clamped firmly.
- Ensure that unused cable entries are sealed with plugs certified in accordance with Directive 94/9/EC or 2014/34/EU, and unused drilled holes are sealed with stopping plugs certified in accordance with Directive 94/9/EC or 2014/34/EU.



## 9 Maintenance and Repair

### 9.1 Maintenance



	You must <b>not</b> carry out maintenance work on built-in elements with flameproof enclosures. In case of damage, replace the built-in element.
---	--

- Consult the relevant national regulations to determine the type and extent of inspections.
- Adapt test intervals to the operating conditions (installation site, weather conditions, utilisation rate of the systems, operating errors, manufacturer's specifications in the technical documentation, changes in the entire system).



At a minimum, check the following points during maintenance work on the device:

- Whether or not the clamping screws holding the electric lines have been firmly tightened
- If the enclosure, actuators and seals are damaged
- Compliance with the permissible temperatures (in accordance with IEC/EN 60079).

### 9.2 Maintenance

	<b>CAUTION</b>
	<p>Danger of electric shock due to live components! Non-compliance can result in minor injuries.</p> <ul style="list-style-type: none"> <li>• Disconnect all connections from the power supply.</li> <li>• Secure the connections against unauthorized switching.</li> <li>• Exception: Devices with intrinsically safe and non-intrinsically safe circuits provided with the note "Non-intrinsically safe circuits protected by internal IP30 cover" may be opened while carrying voltage.</li> </ul>
	Observe the relevant national regulations in the country of use.

### 9.3 Repair

	<b>DANGER</b>
	<p>Explosion hazard due to improper repair! Non-compliance results in severe or fatal injuries.</p> <ul style="list-style-type: none"> <li>• Repair work on the devices must be performed only by R. STAHL Schaltgeräte GmbH.</li> </ul>
	You must <b>not</b> carry out repair work on built-in elements with flameproof enclosures. In case of damage, replace the built-in element.

### 9.4 Returning the Device

Use the "Service form" to return the device if repair or service is required.  
 On the internet site "www.stahl-ex.com" under "Downloads > Customer service":

- Download the service form.
- Fill out the service form.
- Send the device along with the service form in the original packaging to R. STAHL Schaltgeräte GmbH.

## 10 Cleaning

- To avoid electrostatic charging, the devices located in potentially explosive areas may only be cleaned using a damp cloth.
- When cleaning with a damp cloth, use water or mild, non-abrasive, non-scratching cleaning agents.
- Do not use aggressive detergents or solvents.

## 11 Disposal

- Observe national and local regulations and statutory regulation regarding disposal.
- Separate materials when sending it for recycling.
- Ensure environmentally friendly disposal of all components according to the statutory regulations.

## 12 Accessories and Spare Parts

<i><b>NOTICE</b></i>	
<p>Malfunction or damage to the device due to the use of non-original components.                  Non-compliance can result in material damage.</p> <ul style="list-style-type: none"> <li>• Use only original accessories and spare parts from R. STAHL Schaltgeräte GmbH.</li> </ul>	

	<p>For accessories and spare parts, see data sheet on our homepage <a href="http://www.stahl-ex.com">www.stahl-ex.com</a>.</p>
---	--