

Two-channel safety barriers

Series 9002

INTRINSPAK

STAHL

www.stahl.de



04101E00

- > Wide product range for all standard applications of the automation
- > Flexible and space-saving – available in single and double channel versions
- > Time-saving installation thanks to simultaneous
 - snap-on mounting on rails and
 - connection to PE and earth
- > Reduced stock-keeping thanks to a uniform back-up fuse



A2

The R. STAHL INTRINSPAK safety barriers of Series 9002 can be used for various tasks in the field of automation. The wide product range and scope of different combinations offer you a large field of applications.

The safety barriers allow the intrinsically safe operation of HART transmitters, proximity sensors, potential-free contacts, temperature sensors, DMS, solenoid valves, indicators and others. Due to the compact width, space-saving and flexible installation in the switch cabinet is possible. Thanks to DIN-rail mounting and simultaneous connection of the equipotential bonding, the installation can be performed very easily.

	ATEX / IECEx							NEC 505							NEC 506							NEC 500					
	0	1	2	20	21	22		Class I	0	1	2	20	21		22	Division	Class I	Class II	Class III	Class I		Class II	Class III				
Zone	x	x	x	x	x	x	Zone							Division	1	2	1	2	1	2	Class I	Class II	Class III				
Ex i interface	x	x	x	x	x	x	Ex i interface							Ex i interface	x	x	x	x	x	x	x	x	x				
Installation in			x			x	Installation in			x			x	Installation in		x		x			x	x	x				

WebCode 9002A

Explosion Protection

Global (IECEX)

Gas and dust	IECEX PTB 08.0057X Ex nA [ia Ga] IIC T4 Gc [Ex ia Da] IIIC
--------------	--

Europe (ATEX)

Gas and dust	PTB 01 ATEX 2053 X ⊕ II 3 (1) G Ex nA [ia Ga] IIC/IIB T4 Gc ⊕ II (1) D [Ex ia Da] IIIC
--------------	--

Certificates

Certificates	IECEX, ATEX, Brasil (INMETRO), Canada (CSA), Kazakhstan (TR), Korea (KCs), Russia (TR), Serbia (SRPS), Ukraine (TR), USA (FM, UL), Belarus (TR)
--------------	---

Further parameters

Installation	in Zone 2, Division 2 and in safe area
Further information	see respective certificate and operating instructions

Technical Data

Electrical data

Transmission characteristic	
Leakage current at U_N	$\leq 2 \mu\text{A}$ (unless specified otherwise)
Temperature influence	$\leq 0.25 \% / 10 \text{ K}$
Transmission frequency	
In case of resistive current limiting	
$I_m \leq 50 \text{ mA}$	$\leq 50 \text{ kHz}$
$I_m \geq 50 \text{ mA}$	$\leq 100 \text{ kHz}$
In case of electronic current limiting	$\leq 10 \text{ kHz}$

Ambient conditions

Ambient temperature	-20 ... +60 °C
Storage temperature	-20 ... +75 °C
Maximum relative humidity	95 % on average, no condensation

Mechanical data

Degree of protection	according to IEC 60529
Terminal support	IP20
Enclosure	IP40
Enclosure material	polyamide 6GF
Connection type	4 connection terminals (cage terminals), each maximum 1.5 mm ² finely stranded / solid wire 2 PA-terminals, each maximum 4 mm ² finely stranded / solid
Weight	approx 0.115 kg

Two-channel safety barriers, potential: + / +

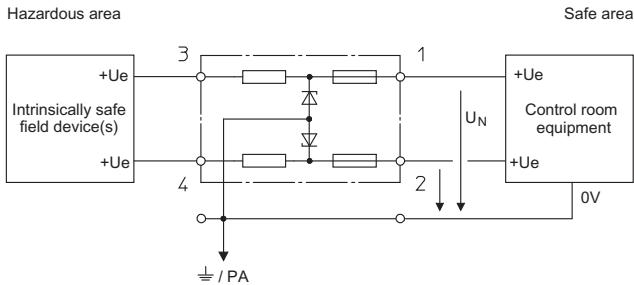

- Connection to regulated power supply U_N
- Installation permitted in Division 2 and Zone 2

05820E01

A2

Selection table

Channel	U_N V	R_{min} Ω	R_{max} Ω	I_{max} mA	Safety data							Order number
					U_o V	I_o mA	P_o mW	IIC mH	IIB μ F	IIB mH	IIB μ F	
1	9	1043	1156	7.7	12	12	40	240	1.41	850	9	9002/11-120-024-001
2	9	1043	1156	7.7	12	12	40	240	1.41	850	9	
1+2	--	--	--	--	12	24	70	63	1.1	230	7.1	
1	10	45	52	100	13	321	1040	0.19	1	1.6	6	9002/11-130-360-001 *)
2	1	45	52	19	1.6	39	16	24	100	91	100	
1+2	--	--	--	--	13	360	1170	0.17	0.79	1.3	5	
1	10	953	978	10	13.7	14.5	50	160	0.79	560	5	9002/11-137-029-001
2	10	953	978	10	13.7	14.5	50	160	0.79	560	5	
1+2	--	--	--	--	13.7	29	100	43	0.67	160	4.18	
1	16	1423	1576	10	19.9	15	75	160	0.223	560	1.42	9002/11-199-030-001
2	16	1423	1576	10	19.9	15	75	160	0.223	560	1.42	
1+2	--	--	--	--	19.9	30	150	40	0.223	150	1.42	
1	22.5	321	358	62	26	87	540	2.7	0.099	15.4	0.77	9002/11-260-138-001
2	17.5	416	463	37	20	51	245	14	0.22	54	1.41	
1+2	--	--	--	--	26	138	785	0.81	0.087	5.1	0.67	
1	25	321	358	69	28	93	650	2	0.083	13	0.65	9002/11-280-186-001
2	25	321	358	69	28	93	650	2	0.083	13	0.65	
1+2	--	--	--	--	28	186	1300	--	--	2.8	0.551	
1	25	321	358	69	28	89	630	2.2	0.083	14	0.65	9002/11-280-293-001
2	6	59	68	88	9.6	180	430	0.6	3.6	5	26	
1+2	--	--	--	--	28	269	1050	--	--	0.56	0.62	

*) max. leakage current $I_{leak} \leq 10 \mu$ A

Functional data and safety-relevant maximum values

U_N	Nominal voltage	I_{max}	Maximum output current	P_o	Maximum power
R_{min}	Minimum resistance of the safety barrier	U_o	Maximum voltage	L_o	max. permissible external inductance
R_{max}	Maximum resistance of the safety barrier	I_o	Maximum current	C_o	max. permissible external capacity

Application case

Load cell (DMS) 350 Ω or 700 Ω
6 conductors + 16 V, field circuit unearthed

Schematic

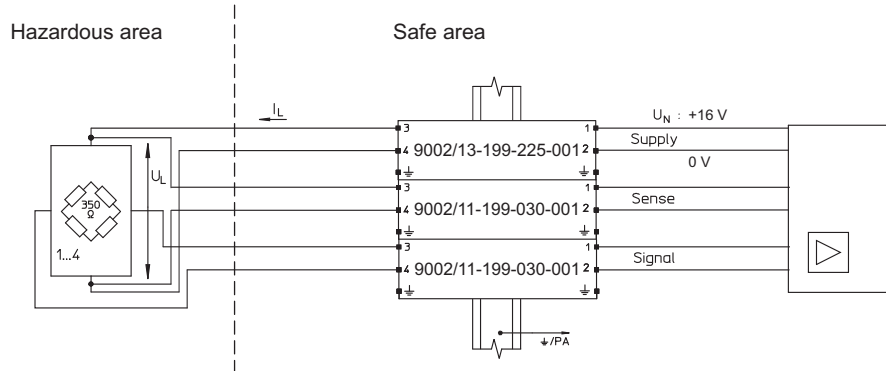

09963E01

Operating data

Operating voltage
Voltage for load cell and electric line
Current for load cell

$U_N \leq +16 \text{ V}$
 U_L (at $U_N = +16 \text{ V}$)
 I_L (at $U_N = +16 \text{ V}$)

Number of the load cells connected in parallel	350 Ω		700 Ω	
	U_L (V)	I_{mA} (V)	U_L (V)	I_{mA} (V)
1	10.4	30	12.1	17
2	8.3	47	10.4	30
3	6.9	60	9.5	41
4	5.9	67	8.3	47

Safety data

Maximum voltage
Maximum current
Maximum permissible external inductance
Maximum permissible external capacity
Maximum power

$U_o = 19.9 \text{ V}$
 $I_o = 285 \text{ mA}$
 L_o IIC 0.2 mH IIB 1.8 mH
 C_o IIC 0.223 μF IIB 1.42 μF
 $P_o = 1.42 \text{ W}$

Application note

For 4-wire circuits (without sense) the respective safety barrier might be unnecessary. The operating data remains unchanged. The safety-relevant maximum current is reduced to $I_o = 255 \text{ mA}$, the maximum power to $P_o = 1.3 \text{ W}$.

3-wire NPN inputs (negative switching) of proximity switches, photocells and encoders

Schematic

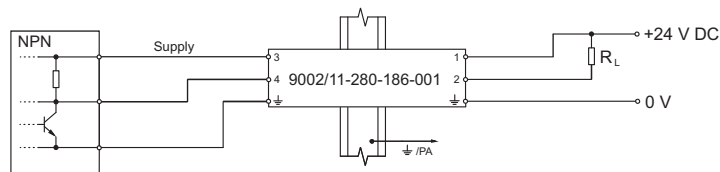

06601E02

Discrete 2-wire output for solenoid valves, LEDs and signalling devices

Schematic

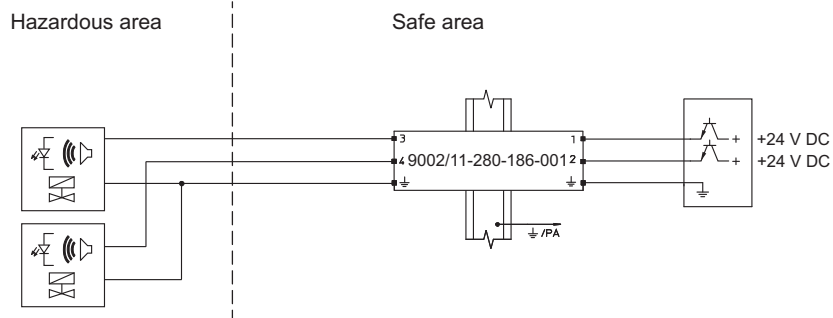

06606E01

Two-channel safety barriers, potential: + / +

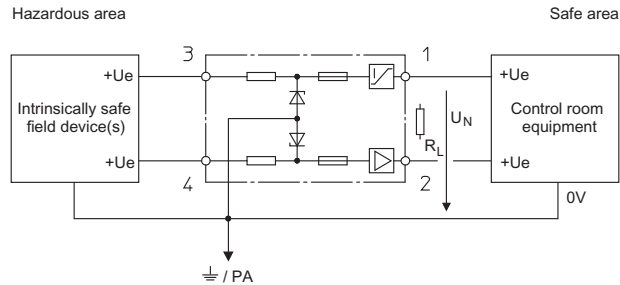

- Application for 3-wire NPN, sensors with voltage output
- Low nominal current
- Installation permitted in Division 2 and Zone 2

05823E02

A2

Selection table

Channel	UN	Rmin	Rmax	Imax	Safety data								Order number
					Uo		Io		P0		IIB		
					V	mA	mW	mH	μF	mH	μF		
1	24	264	296	91	28	109	760	1.3	0.083	9	0.65	9002/11-280-112-001	
2	24	11979	12221	2	28	3	20	50	0.083	150	0.65		
1+2	--	--	--	--	28	112	780	0.76	0.065	84	0.551		

Functional data and safety-relevant maximum values

UN	Nominal voltage	Imax	Maximum output current	P0	Maximum power
Rmin	Minimum resistance of the safety barrier	Uo	Maximum voltage	Lo	max. permissible external inductance
Rmax	Maximum resistance of the safety barrier	Io	Maximum current	Co	max. permissible external capacity

Application case

3-wire NPN inputs (negative switching) of proximity switches, photocells and encoders

Schematic

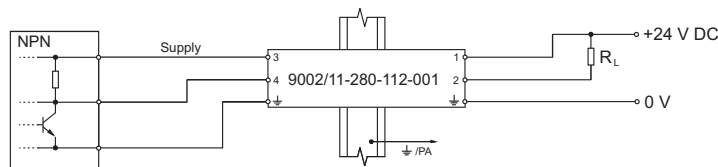

06597E02

Application note

With this barrier all loop voltages must be checked to ensure correct function.

Two-channel safety barriers, potential: + / +

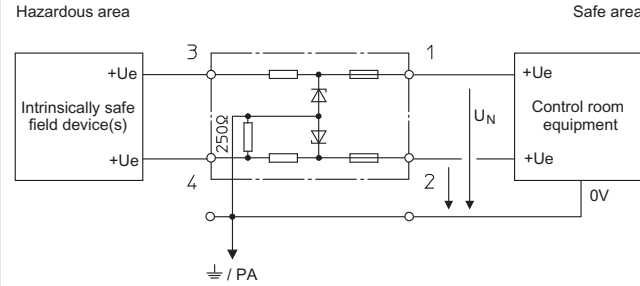

- Application for 4/20 mA transmitter with 1-5 V input in the wiper
- Incl. precision resistance of 250 Ω
- Installation permitted in Division 2 and Zone 2

05824E02

Selection table

Channel	U _N V	R _{min} Ω	R _{max} Ω	I _{max} mA	Safety data							Order number
					U _o V	I _o mA	P _o mW	IIC L _o mH	IIB C _o μF	L _o mH	C _o μF	
1	25	321	358	69	28	89	630	2.2	0.083	14	0.65	9002 / 11 - 280 - 293 - 021
2	6	59	68	88	9.6	180	430	0.6	3.6	5	26	
1+2	--	--	--	--	28	269	1050	--	--	0.56	0.62	

Functional data and safety-relevant maximum values

U _N	Nominal voltage	I _{max}	Maximum output current	P _o	Maximum power
R _{min}	Minimum resistance of the safety barrier	U _o	Maximum voltage	L _o	max. permissible external inductance
R _{max}	Maximum resistance of the safety barrier	I _o	Maximum current	C _o	max. permissible external capacity

Application case

2-wire, 4/20 mA transmitters - standard and HART

Schematic

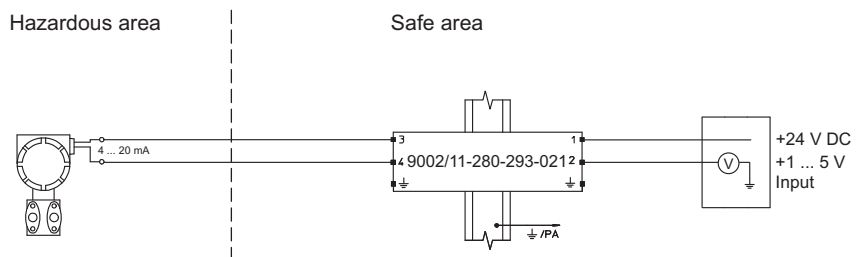

11332E01

Application note

This safety barrier is used if the automation system only accepts signals from 1 to 5 V. This barrier contains a 250 Ω resistor to convert the signal 1 ... 5 V.

Two-channel safety barriers, potential: - / -

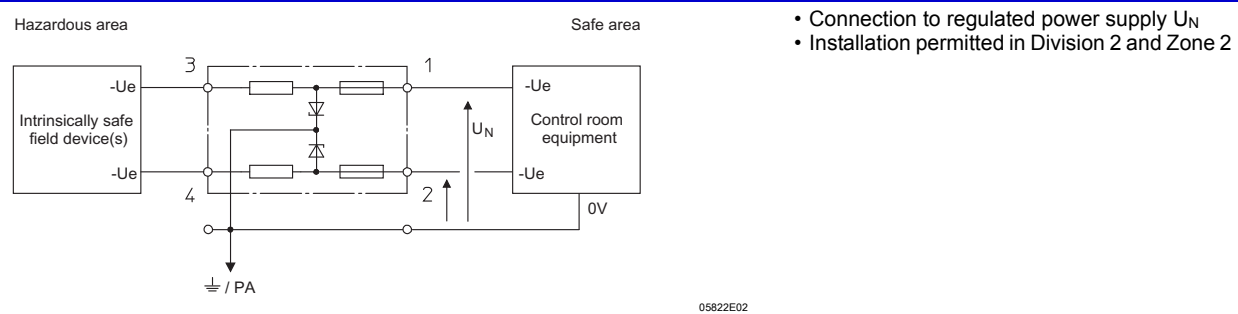

- Connection to regulated power supply U_N
- Installation permitted in Division 2 and Zone 2

A2

Selection table

Channel	U_N	R_{min}	R_{max}	I_{max}	Safety data							Order number
					U_o	I_o	P_o	IIC L_o	IIB C_o	L_o	C_o	
	V	Ω	Ω	mA	V	mA	mW	mH	μF	mH	μF	
1	9	1043	1156	7.7	12	12	40	240	1.41	850	9	9002/00-120-024-001
2	9	1043	1156	7.7	12	12	40	240	1.41	850	9	
1+2	--	--	--	--	12	24	70	63	1.1	230	7.1	
1	22.5	321	358	62	26	87	540	2.7	0.099	15.4	0.77	9002/00-260-138-001
2	17.5	416	463	37	20	51	245	14	0.22	54	1.41	
1+2	--	--	--	--	26	138	785	0.81	0.087	5.1	0.67	
1	25	321	358	69	28	93	650	2	0.083	13	0.65	9002/00-280-186-001
2	25	321	358	69	28	93	650	2	0.083	13	0.65	
1+2	--	--	--	--	28	186	1300	--	--	2.8	0.551	

Functional data and safety-relevant maximum values

U_N	Nominal voltage	I_{max}	Maximum output current	P_o	Maximum power
R_{min}	Minimum resistance of the safety barrier	U_o	Maximum voltage	L_o	max. permissible external inductance
R_{max}	Maximum resistance of the safety barrier	I_o	Maximum current	C_o	max. permissible external capacity

Application case

Vibration sensor

Schematic

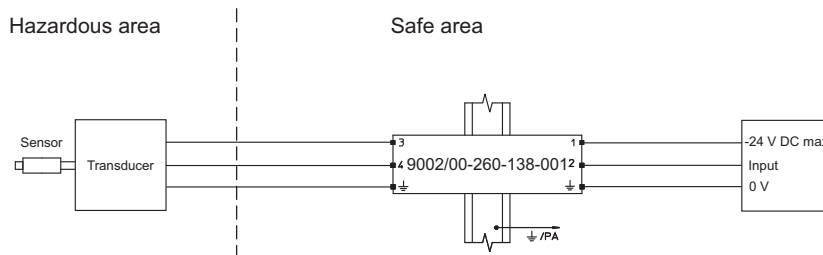

06615E01

Operating data

Operating voltage $U_N = -24V$
Series resistance of the safety barrier $R = 358 \Omega$

Safety data

Maximum voltage $U_o = 26 V$
Maximum current $I_o = 138 mA$
Maximum permissible external inductance
 L_o IIC 0.81 mH IIB 5.1 mH
Maximum permissible external capacity
 C_o IIC 0.087 μF IIB 0.67 μF
Maximum power $P_o = 850 mW$

Application note

Application of the barrier for Bentley Nevada and Metrix position transducer. This barrier has negative potential; for a positive potential, use the barrier 9002/11-260-138-001.

Two-channel safety barriers, potential: + / -

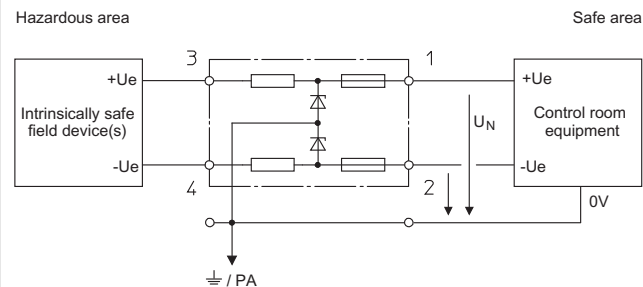

- Application for load cells
- Channel for positive and negative potential in one module
- Installation permitted in Division 2 and Zone 2

05821E02

Selection table

Channel	U _N V	R _{min} Ω	R _{max} Ω	I _{max} mA	Safety data								Order number		
					U _o V		I _o mA		P _o mW		IIC			IIB	
					L _o mH	C _o μF	L _o mH	C _o μF	L _o mH	C _o μF	L _o mH	C _o μF			
1	6	490	543	11	9.33	20	50	90	3.9	330	29	9002 / 10 - 187 - 020 - 001			
2	6	490	543	11	9.33	20	50	90	3.9	330	29				
1+2	--	--	--	--	18.7	20	90	90	0.27	330	1.64				
1	6	42	49	122	9.33	270	630	0.23	3.9	2.2	29	9002 / 10 - 187 - 270 - 001			
2	6	42	49	122	9.33	270	630	0.23	3.9	2.2	29				
1+2	--	--	--	--	18.7	270	1260	0.23	0.27	2.2	1.64				

Functional data and safety-relevant maximum values

Parameter	Description	Symbol	Description	Symbol	Description
U _N	Nominal voltage	I _{max}	Maximum output current	P _o	Maximum power
R _{min}	Minimum resistance of the safety barrier	U _o	Maximum voltage	L _o	max. permissible external inductance
R _{max}	Maximum resistance of the safety barrier	I _o	Maximum current	C _o	max. permissible external capacity

Application case

Load cell (DMS) 350 Ω or 700 Ω
6 conductors +/- 7.5 V (15 V), field circuit unearthed

Schematic

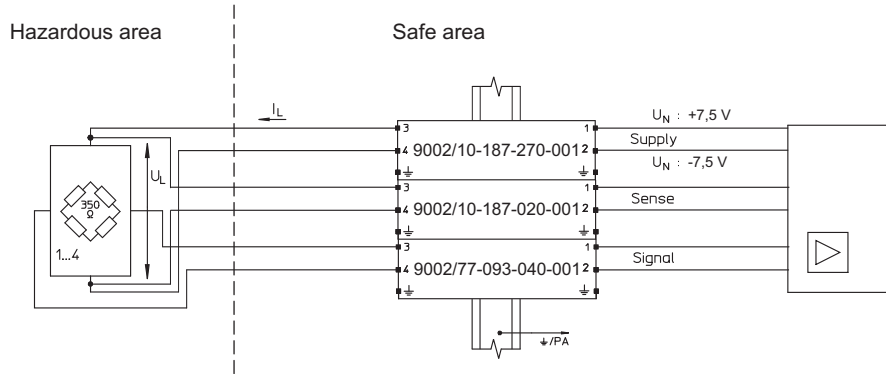

09962E01

Operating data

Operating voltage
Voltage for load cell and electric line
Current for load cell

$U_N \leq \pm 7.5 \text{ V (15 V)}$
 $U_L \text{ (at } U_N \leq \pm 7.5 \text{ V)}$
 $I_L \text{ (at } U_N \leq \pm 7.5 \text{ V)}$

Number of the load cells connected in parallel	350 Ω		700 Ω	
	$U_L \text{ (V)}$	$I_{mA} \text{ (V)}$	$U_L \text{ (V)}$	$I_{mA} \text{ (V)}$
1	11.6	35	13.2	19
2	9.6	55	11.6	35
3	8	70	10.6	45
4	7	80	9.6	55

Safety data

Maximum voltage
Maximum current
Maximum permissible external inductance
Maximum permissible external capacity
Maximum power

$U_o = 18.7 \text{ V}$
 $I_o = 330 \text{ mA}$
 L_o IIC 0.18 mH IIB 1.45 mH
 C_o IIC 0.27 μF IIB 1.64 μF
 $P_o = 1.45 \text{ W}$

Application note

For 4-wire circuits (without sense) the respective safety barrier might be unnecessary. The operating data remains unchanged. The safety-relevant maximum current is reduced to $I_o = 310 \text{ mA}$, the maximum power to $P_o = 1.36 \text{ W}$.

Two-channel safety barriers, potential: ~ / ~

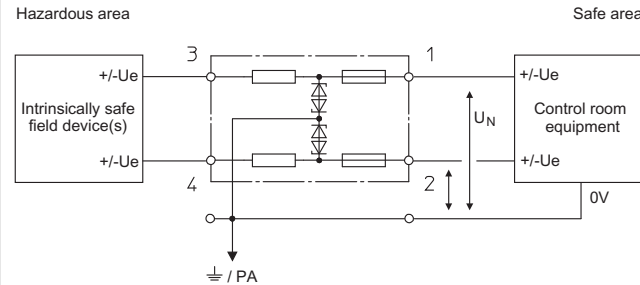

- Connection of a resistance teletransmitter is possible
- High precision resistance of each channel, $20 \Omega \pm 0.1$
- Low temperature influence of $< 50 \text{ ppm/K}$
- Connection to regulated power supply U_N
- Installation permitted in Division 2 and Zone 2

05835E02

Selection table

Channel	U_N V	R_{min} Ω	R_{max} Ω	I_{max} mA	Safety data								Order number
					U_o			IIC		IIB			
					V	mA	mW	L_o mH	C_o μF	L_o mH	C_o μF		
1	0.7	19.9	20.1	33	1.6	150	60	1.3	100	7	1000	9002/22-032-300-111 *)	
2	0.7	19.9	20.1	33	1.6	150	60	1.3	100	7	1000		
1+2	1.4	--	--	--	3.2	300	120	0.2	100	1.8	1000		

*) max. leakage current $I_{leak} \leq 10 \mu A$

Functional data and safety-relevant maximum values

Parameter	Description	Symbol	Description	Symbol	Description
U_N	Nominal voltage		Maximum output current	I_{max}	Maximum power
R_{min}	Minimum resistance of the safety barrier	U_o	Maximum voltage	L_o	max. permissible external inductance
R_{max}	Maximum resistance of the safety barrier	I_o	Maximum current	C_o	max. permissible external capacity

Application case

Pt100, 2-wire circuit, field circuit unearthed

Schematic

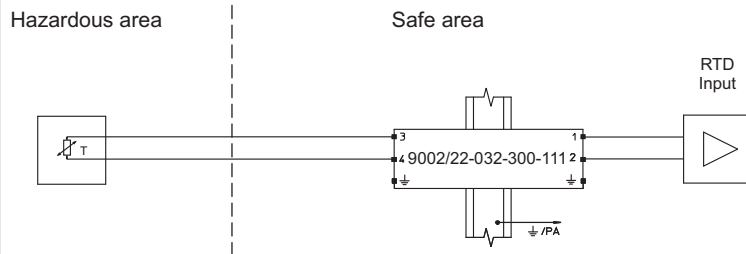

09959E01

Operating data

Operating voltage	$U_N \leq 1.4 \text{ V}$
Series resistance of the safety barrier	$R = 2 \times (20 \Omega \pm 0.1 \Omega)$
Measuring range	$\leq 400 \text{ }^\circ\text{C}$ ($I_N \leq 5 \text{ mA}$) $\leq 850 \text{ }^\circ\text{C}$ ($I_N \leq 3 \text{ mA}$)

Safety data

Maximum voltage	$U_o = 3.2 \text{ V}$	
Maximum current	$I_o = 300 \text{ mA}$	
Maximum permissible external inductance	L_o	IIB 1.8 mH
		IIC 0.2 mH
Maximum permissible external capacity	C_o	IIB 1000 μF
		IIC 100 μF

Pt100, 3-wire circuit, field circuit unearthed

Schematic

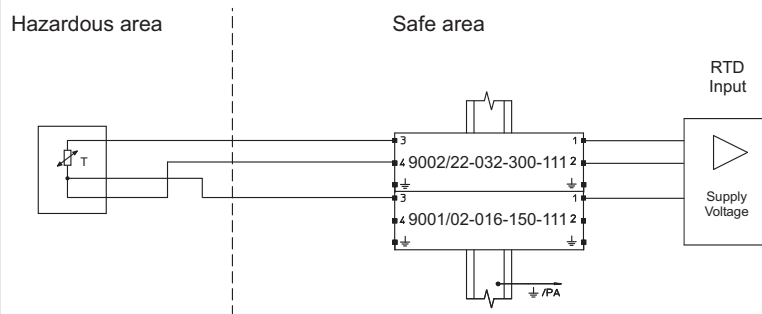

09960E01

Operating data

Operating voltage	$U_N \leq 1.4 \text{ V}$
Series resistance of the safety barrier	$R = 2 \times (20 \Omega \pm 0.1 \Omega)$
Measuring range	$\leq 400 \text{ }^\circ\text{C}$ ($I_N \leq 5 \text{ mA}$) $\leq 850 \text{ }^\circ\text{C}$ ($I_N \leq 3 \text{ mA}$)

Safety data

Maximum voltage	$U_o = 3.2 \text{ V}$	
Maximum current	$I_o = 450 \text{ mA}$	
Maximum permissible external inductance	L_o	IIB 0.5 mH
		IIC 0.12 mH
Maximum permissible external capacity	C_o	IIB 1000 μF
		IIC 100 μF

Two-channel safety barriers, potential: ~ / ~

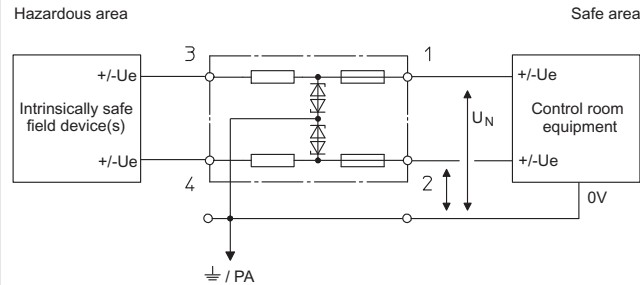

- Connection to regulated power supply U_N
- Installation permitted in Division 2 and Zone 2

05845E02

Selection table

Channel	U_N	R_{min}	R_{max}	I_{max}	Safety data								Order number
					U_o	I_o	P_o	IIC		IIB			
	V	Ω	Ω	mA	V	mA	mW	L _o (mH)	C _o (μ F)	L _o (mH)	C _o (μ F)		
1	5.5	84	95	57	7.9	100	198	4	8.8	15	115	9002/22-158-200-001	
2	5.5	84	95	57	7.9	100	198	4	8.8	15	115		
1+2	11	--	--	--	15.8	200	395	0.5	0.478	4	2.88		
1	9	1043	1156	7.7	12	12	40	240	1.41	850	9	9002/22-240-024-001	
2	9	1043	1156	7.7	12	12	40	240	1.41	850	9		
1+2	18	--	--	--	24	24	80	41	0.125	145	0.93		
1	9	158	177	50	12	80	240	6	1.41	22	9	9002/22-240-160-001	
2	9	158	177	50	12	80	240	6	1.41	22	9		
1+2	18	--	--	--	24	160	480	0.7	0.125	4	0.93		

Functional data and safety-relevant maximum values

U_N	Nominal voltage	I_{max}	Maximum output current	P_o	Maximum power
R_{min}	Minimum resistance of the safety barrier	U_o	Maximum voltage	L_o	max. permissible external inductance
R_{max}	Maximum resistance of the safety barrier	I_o	Maximum current	C_o	max. permissible external capacity

Application case

with RS 232

Schematic

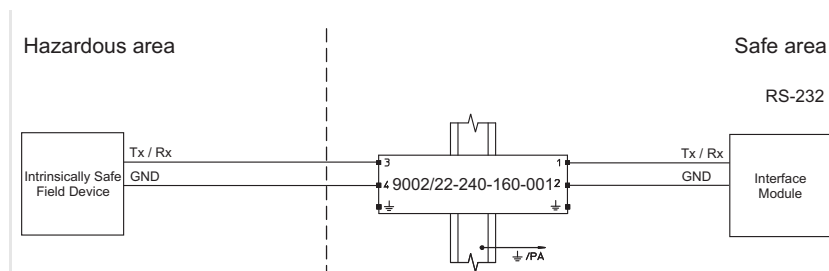

06624E01

Two-channel safety barriers, safety barrier potential: + / evaluation barrier potential: +

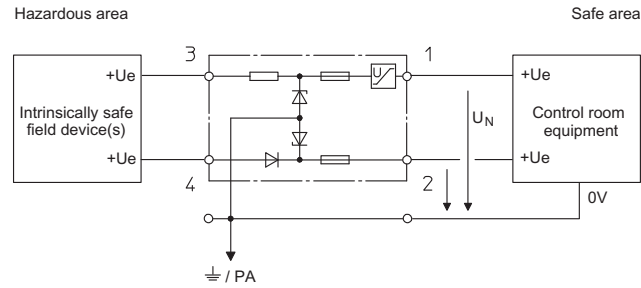

- Function:
Channel 1 current supply
Channel 2 evaluation barrier
No safety-relevant output current I_o for channel 2
- Nominal current limited to 40 mA at 250 Ω load
- Connection to unregulated power supply on U_N to channel 1
- Installation permitted in Division 2 and Zone 2

05439E02

Selection table

Channel	U_N V	R_{min} Ω	R_{max} Ω	I_{max} mA	ΔU V	Safety data							Order number
						U_o V	I_o mA	P_o mW	IIC		IIB		
									L_o mH	C_o μF	L_o mH	C_o μF	
1	20 - 35	216	243	86	--	25.2	118	740	1.3	0.107	7.4	0.82	9002 / 13-252-121-041 ^{*)}
2	22	--	--	--	3.5	25.2	0	20	50	0.107	150	0.82	
1+2	--	--	--	--	--	25.2	121	760	1.25	0.104	7.35	0.8	

^{*)} only for channel 1: leakage current at 24 V / 35 V $I_{leak} \leq 1$ mA / 10 mA

Functional data and safety-relevant maximum values

U_N	Nominal voltage	ΔU	Additional voltage drop across the safety barrier	L_o	max. permissible external inductance
R_{min}	Minimum resistance of the safety barrier	U_o	Maximum voltage	C_o	max. permissible external capacity
R_{max}	Maximum resistance of the safety barrier	I_o	Maximum current		
I_{max}	Maximum output current	P_o	Maximum power		

Application case

Analog output (current source) for I/P converter etc., field circuit unearthed

Schematic

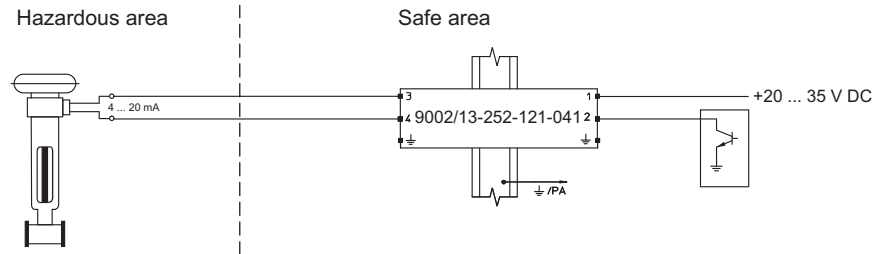

09953E01

Operating data

Operating voltage $U_N = + 20 \dots 35 \text{ V}$
 Operating current $I_N = 0 \dots 22 \text{ mA}$
 Maximum voltage drop at the safety barrier $\Delta U_{\text{max}} (8.9 \text{ V}$

Safety data

Maximum voltage $U_o = 25.2 \text{ V}$
 Maximum current $I_o = 121 \text{ mA}$
 Maximum permissible external inductance

L_o	IIC	IIB
	1.25 mH	7.35 mH

 Maximum permissible external capacity

C_o	IIC	IIB
	0.104 μF	0.8 μF

 Maximum power $P_o = 763 \text{ mW}$

Analog output (current source) for I/P converter etc., field circuit unearthed

Schematic

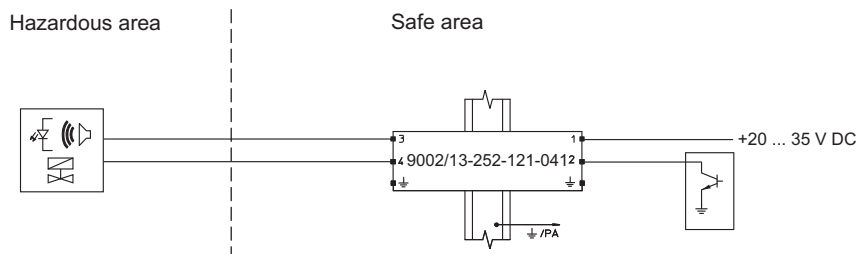

06604E01

Operating data

Operating voltage $U_N = + 20 \dots 35 \text{ V}$
 Open-circuit output voltage (terminal 3 4, $I_n = 0$)

U_L	$U_N (24 \text{ V}$	$U_N > 24 \text{ V}$
	$U_N - 3.5 \text{ V}$	21 V

 Operating current $I_N = U_L / 243 \Omega + R_L$

Safety data

Maximum voltage $U_o = 25.2 \text{ V}$
 Maximum current $I_o = 121 \text{ mA}$
 Maximum permissible external inductance

L_o	IIC	IIB
	1.25 mH	7.35 mH

 Maximum permissible external capacity

C_o	IIC	IIB
	0.104 μF	0.8 μF

 Maximum power $P_o = 760 \text{ mW}$

Application note

This safety barrier is used if the automation system activates the analog output signal in the return (negative) line. The field device and automation system are not earthed and unregulated power supply can be used.

Two-channel safety barriers, safety barrier potential: + / evaluation barrier potential: +

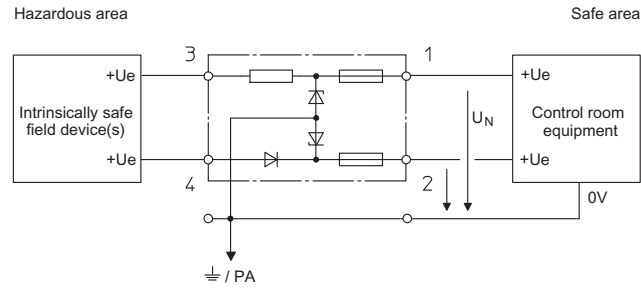

- Function:
Channel 1 current supply
Channel 2 evaluation barrier
- Connection to regulated power supply U_N
- Installation permitted in Division 2 and Zone 2

05826E02

Selection table

Channel	U_N	R_{min}	R_{max}	I_{max}	ΔU	Safety data							Order number
						U_o	I_o	P_o	IIC		IIB		
									L_o	C_o	L_o	C_o	
V	Ω	Ω	mA	V	V	mA	mW	mH	μF	mH	μF		
1	16	95	108	148	--	19.9	222	1100	0.39	0.223	3.18	1.42	9002/13-199-225-001 ^{*)}
2	16	--	--	--	2	19.9	3	15	1000	0.223	1000	1.42	
1+2	--	--	--	--	--	19.9	225	1120	0.37	0.213	3.15	1.38	
1	24	321	358	67	--	28	90	630	2.2	0.083	14	0.65	9002/13-280-093-001
2	24	--	--	--	2	28	3	21	50	0.083	150	0.65	
1+2	--	--	--	--	--	28	93	651	2	0.08	13	0.636	
1	24	269	290	82	--	28	107	749	1.35	0.083	9.6	0.65	9002/13-280-110-001
2	24	--	--	--	2	28	3	21	50	0.083	150	0.65	
1+2	--	--	--	--	--	28	110	770	1.25	0.08	9	0.635	

^{*)} only for channel 2: max. leakage current $I_{leak} \leq 10 \mu A$

Functional data and safety-relevant maximum values

U_N	Nominal voltage	ΔU	Additional voltage drop across the safety barrier	L_o	max. permissible external inductance
R_{min}	Minimum resistance of the safety barrier	U_o	Maximum voltage	C_o	max. permissible external capacity
R_{max}	Maximum resistance of the safety barrier	I_o	Maximum current		
I_{max}	Maximum output current	P_o	Maximum power		

Application case

Load cell (DMS) 350 Ω or 700 Ω
6 conductors + 16 V, field circuit unearthed
Schematic

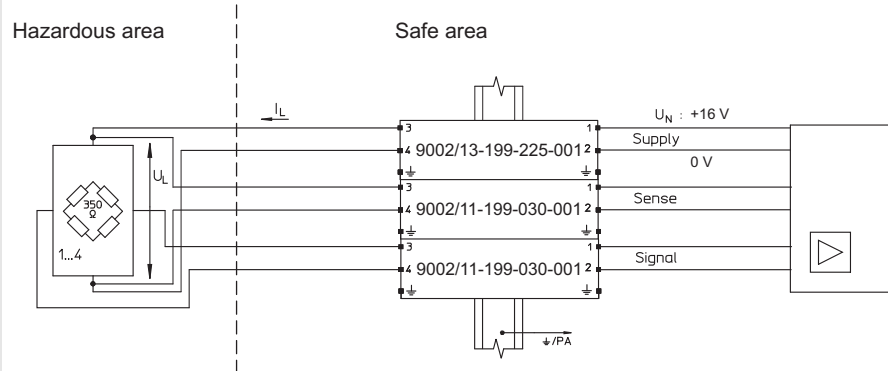

09963E01

Operating data

Operating voltage
Voltage for load cell and electric line
Current for load cell

$U_N \leq +16 \text{ V}$
 U_L (at $U_N = +16 \text{ V}$)
 I_L (at $U_N = +16 \text{ V}$)

Number of the load cells connected in parallel	350 Ω		700 Ω	
	U_L (V)	I_{mA} (V)	U_L (V)	I_{mA} (V)
1	10.4	30	12.1	17
2	8.3	47	10.4	30
3	6.9	60	9.5	41
4	5.9	67	8.3	47

Safety data

Maximum voltage
Maximum current
Maximum permissible external inductance
Maximum permissible external capacity
Maximum power

$U_o = 19.9 \text{ V}$
 $I_o = 285 \text{ mA}$
 L_o IIC 0.2 mH IIB 1.8 mH
 C_o IIC 0.223 μF IIB 1.42 μF
 $P_o = 1.42 \text{ W}$

Application note

For 4-wire circuits (without sense) the respective safety barrier might be unnecessary. The operating data remains unchanged. The safety-relevant maximum current is reduced to $I_o = 255 \text{ mA}$, the maximum power to $P_o = 1.3 \text{ W}$.

Discrete 2-wire output for solenoid valves, LEDs and signalling devices

Schematic

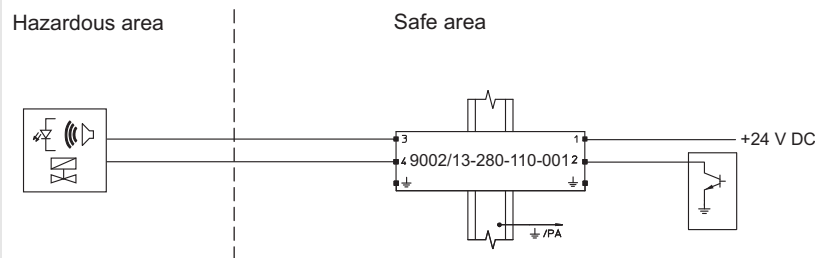

06605E01

Application note

This barrier is suitable for use with regulated power supplies and earthed return circuits. The nominal voltage is 24 V.

2-wire 4/20 mA I/P converters and control valves - standard and HART, 4/20 mA indicators

Schematic

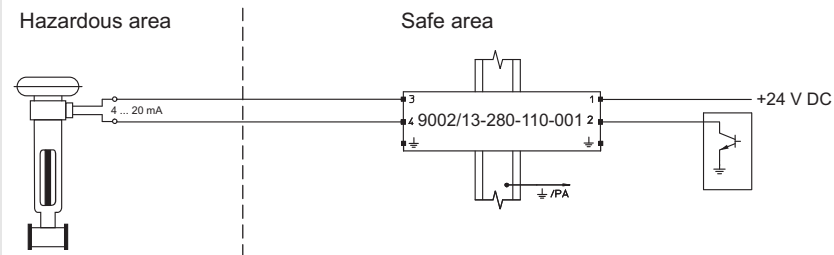

11334E01

Application note

This safety barrier is used if the automation system activates the analog output signal in the return (negative) line. The field device and automation system are not earthed and a regulated power supply must be used. At an operating current of 0 ... 22 mA, the maximum voltage drop across the barrier will be 8.4 V.

Two-channel safety barriers, safety barrier potential: + / evaluation barrier potential: +

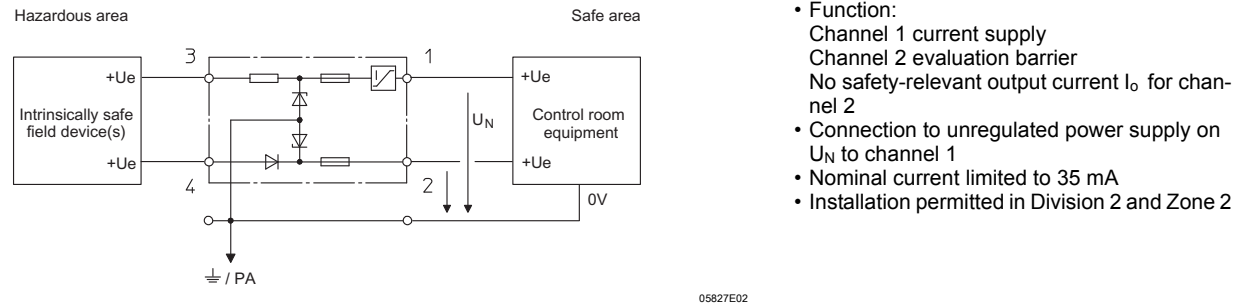

- Function:
Channel 1 current supply
Channel 2 evaluation barrier
No safety-relevant output current I_o for channel 2
- Connection to unregulated power supply on U_N to channel 1
- Nominal current limited to 35 mA
- Installation permitted in Division 2 and Zone 2

A2

Selection table

Channel	U_N V	R_{min} Ω	R_{max} Ω	I_{max} mA	ΔU V	Safety data								Order number
						U_o V	I_o mA	P_o mW	IIC		IIB			
									L_o mH	C_o μF	L_o mH	C_o μF		
1	20 - 35	292	327	35	--	28	97	679	1.8	0.083	12	0.65	9002/13-280-100-041 *)	
2	26	--	--	--	3.5	28	0	21	50	0.083	150	0.65		
1+2	--	--	--	--	--	28	100	700	1.55	0.08	11	0.635		

*) only for channel 1: leakage current $< 26 V / > 26 V I_{leak} \leq 1 mA / 35 mA$

Functional data and safety-relevant maximum values

U_N	Nominal voltage	ΔU	Additional voltage drop across the safety barrier	L_o	max. permissible external inductance
R_{min}	Minimum resistance of the safety barrier	U_o	Maximum voltage	C_o	max. permissible external capacity
R_{max}	Maximum resistance of the safety barrier	I_o	Maximum current		
I_{max}	Maximum output current	P_o	Maximum power		

Application case

3-wire PNP inputs (positive switching) of proximity switches, photocells and encoders

Schematic

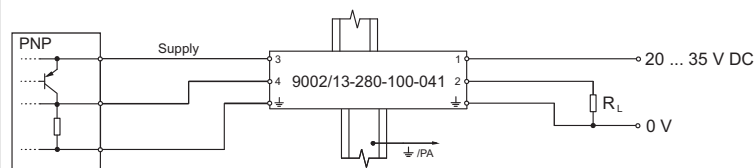

Two-channel safety barriers, evaluation barrier potential: + / evaluation barrier potential: +

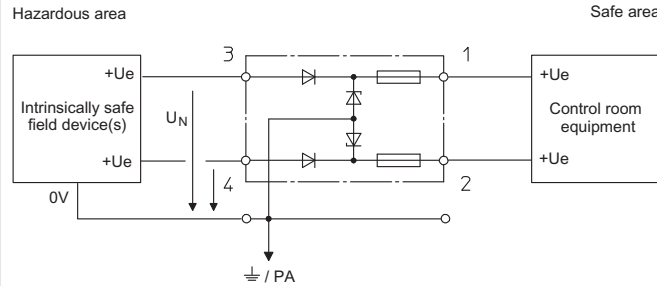

- Evaluation barrier for direct current signals with max. output current I_o
- Suitable for potential-free contacts and floating 4/20 mA signals
- Positive potential of both channels
- Installation permitted in Division 2 and Zone 2

05829E02

Selection table

Channel	U_N V	I_{max} mA	ΔU V	Safety data						Order number
				U_o V	I_o mA	IIC L_o mH	C_o μF	IIB L_o mH	C_o μF	
1	25.5	60	3.5 ^{*)}	28	0	1000	0.083	1000	0.65	9002/33-280-000-001
2	25.5	60	3.5 ^{*)}	28	0	1000	0.083	1000	0.65	
1+2	--	--	--	28	0	1000	0.083	1000	0.65	

^{*)} 2.5 V to 20 mA

Functional data and safety-relevant maximum values

U_N	Nominal voltage	U_o	Maximum voltage	C_o	max. permissible external capacity
I_{max}	Maximum output current	I_o	Maximum current		
ΔU	Additional voltage drop across the safety barrier	L_o	max. permissible external inductance		

Application case

Combination of potential-free contacts

Schematic

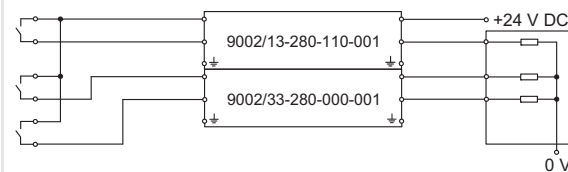

14682E00

Two-channel safety barriers, evaluation barrier potential: + / evaluation barrier potential: -

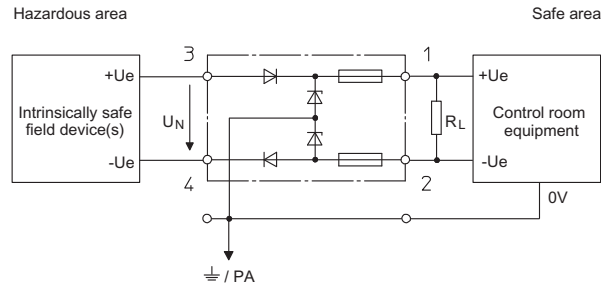

05828E02

- Evaluation barrier for direct current signals with max. output current I_o
- Application for passive signals of 4/20 mA (transmitter with 4 conductors or more) with insulated analog input on the control system
- Channel for positive and negative potential in one module
- Installation permitted in Division 2 and Zone 2

A2

Selection table

Channel	U_N V	I_{max} mA	ΔU V	Safety data						Order number
				U_o V	I_o mA	IIC L_o mH	IIB C_o μF	L_o mH	C_o μF	
1	+ 16	100	3.5 ^{*)}	28	0	1000	0.22	1000	1.14	9002/34-280-000-001
2	- 5	100	3.5 ^{*)}	8	0	1000	8.4	1000	100	
1+2	21	--	--	28	0	1000	0.083	1000	0.65	

^{*)} 2.5 V to 20 mA

Functional data and safety-relevant maximum values

U_N	Nominal voltage	U_o	Maximum voltage	C_o	max. permissible external capacity
I_{max}	Maximum output current	I_o	Maximum current		
ΔU	Additional voltage drop across the safety barrier	L_o	max. permissible external inductance		

Application case

Transmitter (4-wire)

Schematic

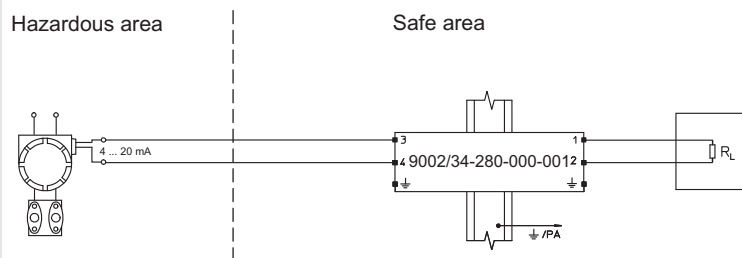

09951E011

Operating data

Operating current $I_N = 0 \dots 22 \text{ mA}$
Load $R_L \leq 750 \Omega$
Maximum voltage drop at the safety barrier $\Delta U_{max} \leq 3.5 \text{ V}$

Safety data

Maximum voltage $U_o = 28 \text{ V}$
Maximum current $I_o = 0 \text{ mA}$
Maximum permissible external inductance The inductance is determined depending on the maximum current of the transmitter

Maximum permissible external capacity C_o IIC 0.083 μF IIB 0.65 μF

Maximum power $P_o = 0 \text{ mW}$

Application note

A potential-free input is required for the circuit.
If the input is earthed, (R_L to $/PA$), the safety barrier 9001/03-280-000-001 can be used.

Two-channel safety barriers, star barrier / star barrier

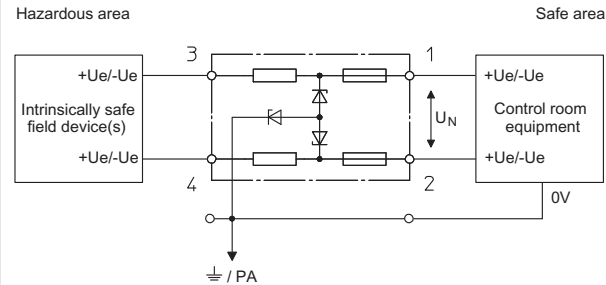

- Connection to regulated power supply U_N
- Suitable for voltage signals
- Installation permitted in Division 2 and Zone 2
- AC version

05836E02

Selection table

Channel	U_N	R_{min}	R_{max}	Safety data								Order number
				U_o	I_o	P_o	IIC		IIB			
	V	Ω	Ω	V	mA	mW	L_o	C_o	L_o	C_o		
							mH	μF	mH	μF		
1 2 1+2	6	492 492 --	545 545 --	9.3 9.3 9.3	20 20 40	50 50 90	90 90 23	4.1 4.1 4.1	330 330 87	31 31 31	9002/77-093-040-001	
1 2 1+2	6	71 71 --	82.1 82.1 --	9.3 9.3 9.3	150 150 300	350 350 700	1.3 1.3 0.2	4.1 4.1 4.1	7 7 1.8	31 31 31	9002/77-093-300-001	
1 2 1+2	6	60 60 --	69.2 69.2 --	10 10 10	200 200 400	500 500 1000	0.5 0.5 0.15	3 3 3	4 4 0.8	20.2 20.2 20.2	9002/77-100-400-001	
1 2 1+2	12	111 111 --	126 126 --	15 15 15	150 150 300	560 560 1130	1.3 1.3 0.2	0.58 0.58 0.58	7 7 1.8	3.55 3.55 3.55	9002/77-150-300-001	
1 2 1+2	18	321 321 --	358 358 --	22 22 22	73 73 146	400 400 800	7 7 1.4	0.165 0.165 0.165	26 26 7.4	1.14 1.14 1.14	9002/77-220-146-001 *)	
1 2 1+2	18	159 159 --	180 180 --	22 22 22	148 148 296	810 810 1630	1.35 1.35 0.24	0.165 0.165 0.165	7.2 7.2 1.84	1.14 1.14 1.14	9002/77-220-296-001 *)	
1 2 1+2	24	657 657 --	730 730 --	28 28 28	47 47 94	330 330 660	10.1 10.1 1.96	0.083 0.083 0.083	30 30 12.5	0.65 0.65 0.65	9002/77-280-094-001	

*) Ambient temperature - 20 ... + 50 °C

Functional data and safety-relevant maximum values

U_N	Nominal voltage	U_o	Maximum voltage	L_o	max. permissible external inductance
R_{min}	Minimum resistance of the safety barrier	I_o	Maximum current	C_o	max. permissible external capacity
R_{max}	Maximum resistance of the safety barrier	P_o	Maximum power		

Application case

Load cell (DMS) 350 Ω or 700 Ω
6 conductors +/- 7.5 V (15 V), field circuit unearthed

Schematic

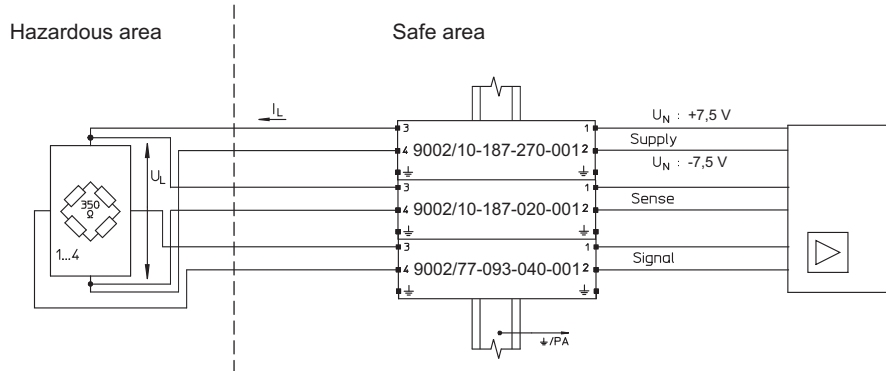

09962E01

Operating data

Operating voltage
Voltage for load cell and electric line
Current for load cell

$U_N \leq \pm 7.5 \text{ V (15 V)}$
 $U_L \text{ (at } U_N \leq \pm 7.5 \text{ V)}$
 $I_L \text{ (at } U_N \leq \pm 7.5 \text{ V)}$

Number of the load cells connected in parallel	350 Ω		700 Ω	
	$U_L \text{ (V)}$	$I_{mA} \text{ (V)}$	$U_L \text{ (V)}$	$I_{mA} \text{ (V)}$
1	11.6	35	13.2	19
2	9.6	55	11.6	35
3	8	70	10.6	45
4	7	80	9.6	55

Safety data

Maximum voltage
Maximum current
Maximum permissible external inductance
Maximum permissible external capacity
Maximum power

$U_o = 18.7 \text{ V}$
 $I_o = 330 \text{ mA}$
 L_o IIC 0.18 mH IIB 1.45 mH
 C_o IIC 0.27 μF IIB 1.64 μF
 $P_o = 1.42 \text{ W}$

Application note

For 4-wire circuits (without sense) the respective safety barrier might be unnecessary. The operating data remains unchanged. The safety-relevant maximum current is reduced to $I_o = 310 \text{ mA}$, the maximum power to $P_o = 1.36 \text{ W}$.

Thermocouples

Schematic

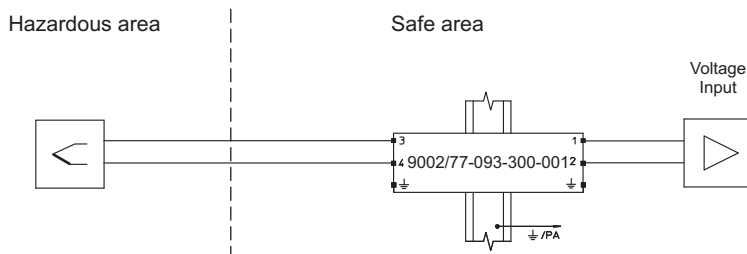

09958E01

Operating data

Maximum series resistance of the safety barrier
Sensor voltage

$R_{max} = 2 \times 82.1 \Omega$
 $U \leq \pm 4 V_{eff} / 6 V_{pp}$

Safety data

Maximum voltage
Maximum current
Maximum permissible external inductance
Maximum permissible external capacity









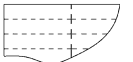

$U_o = 9.3 \text{ V}$
 $I_o = 300 \text{ mA}$
 L_o IIC 0.2 mH IIB 1.8 mH
 C_o IIC 4.1 μF IIB 31 μF

Two-channel safety barriers

Series 9002

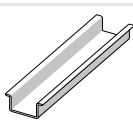
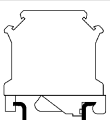
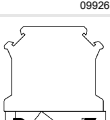

Accessories and Spare Parts

Designation	Figure	Description	Art. no.	Weight kg
Back-up fuse	 09919E00	for all safety barriers of Series 9001, 9002 and 9004 Packaging unit: 5 pieces	158964	0.008
Label carrier	  09920E00		158977	0.002
Labelling sheet	 09921E00	perforated, for automatic inscription Format: DIN A4	158973	0.005
Adapter	  09922E00		158826	0.006
Clamping base, moulded material	 09924E00		165283	0.004
DIN rail	 03856E00	NS 35 / 15 (available by the metre)	103714	1.410
Protective conductor terminal	 09926E00	USLKG 5 (clamping range $\leq 4 \text{ mm}^2$)	112760	0.012
Earthing terminal	 09926E00	USLKG 6 N (clamping range $\leq 6 \text{ mm}^2$)	112599	0.030
Fuse holder	  09927E00		158834	0.020
Insulation and fastening material	  09928E00	for mounting rail NS 35/15	158828	0.023

Dimensional Drawings (All Dimensions in mm / inches) - Subject to Alterations

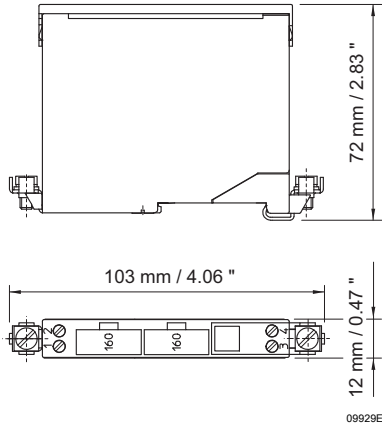

Safety barriers 9001, 9002, 9004

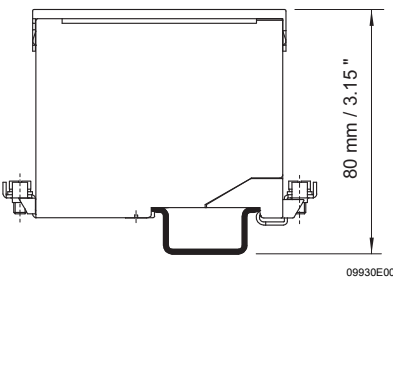

Safety barrier 9001, 9002, 9004
mounted on the mounting rail LV 35/15

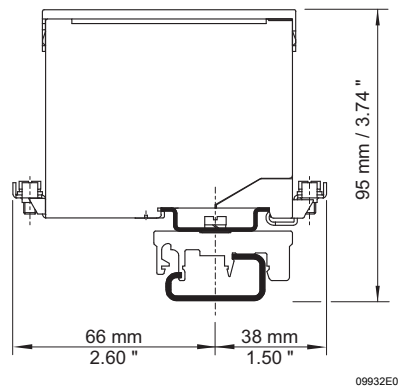

Safety barrier 9001, 9002, 9004
mounted on the mounting rail LV 32
with adaptor and clamping base made of
moulded material

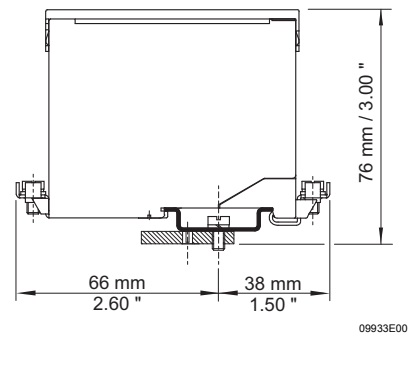

Safety barrier 9001, 9002, 9004
mounted on
mounting plate with adaptor

We reserve the right to make alterations to the technical data, dimensions, weights, designs and products available without notice. The illustrations cannot be considered binding.